

Type of adjustment set : M16 intermediate hex-rod
M16系列調整組

Adjust the length by section (A). After the length setting is completed, tighten nut (B).
使用 (A) 部份調整所需長短，再鎖緊 (B)

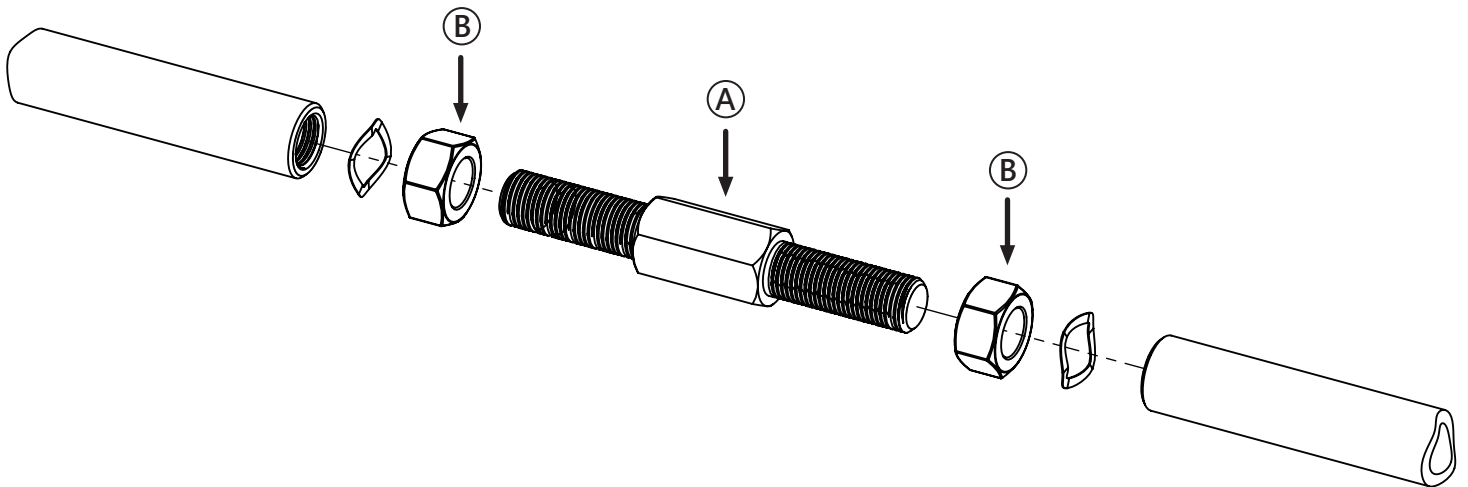

※ Attention! Pillow ball bush and Ball joint must be kept in the middle position
注意！魚眼及和尚頭必須保持在置中位置

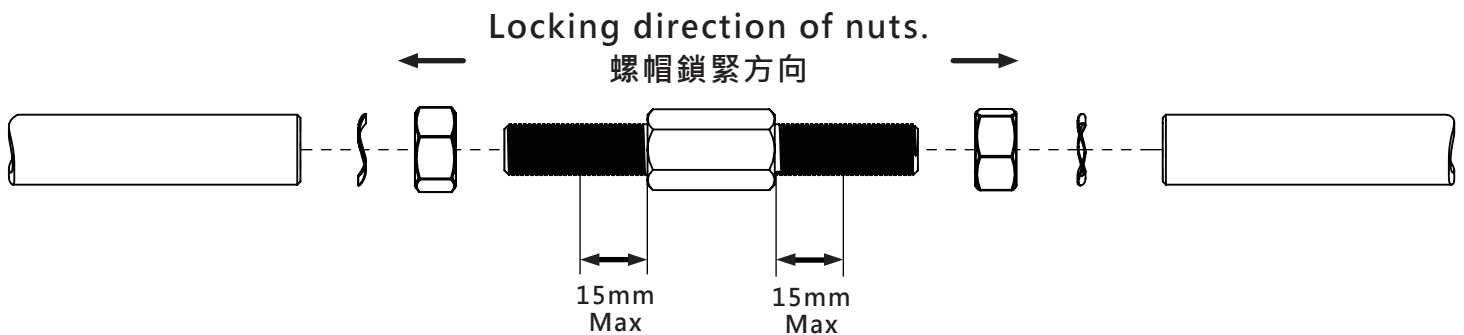

※ Safety adjustment length: Within 30mm
調整安全長度30mm以內

