

Type of adjustment set : M16 thread series
M16系列調整組

Adjust the length by screwing section (A). After the length setting is completed, tighten nuts (B).
使用 (A) 部份調整所需長短，再鎖緊 (B) 部分

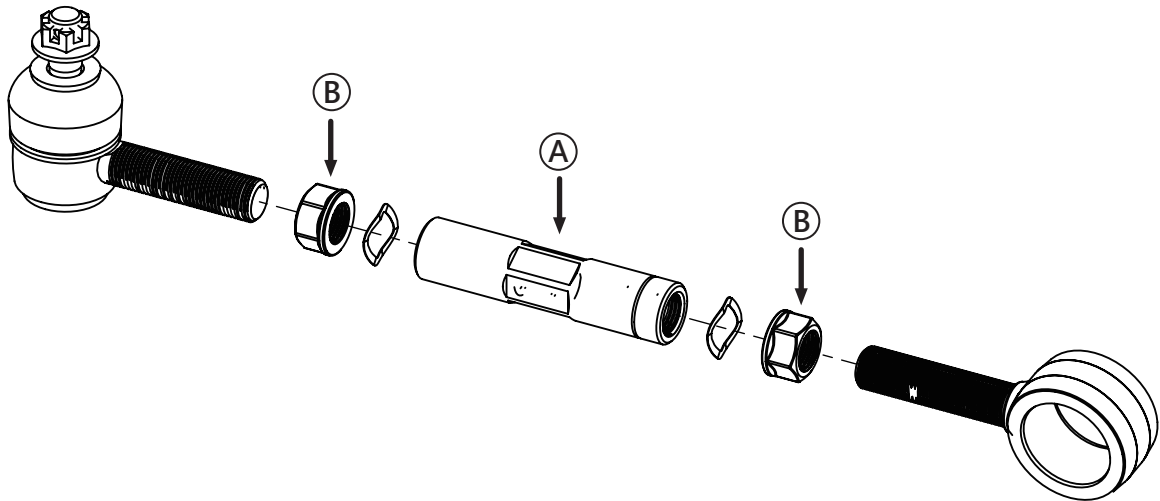

※ Attention! Pillow ball bush and Ball joint must be kept in the middle position
注意！魚眼及和尚頭必須保持在置中位置

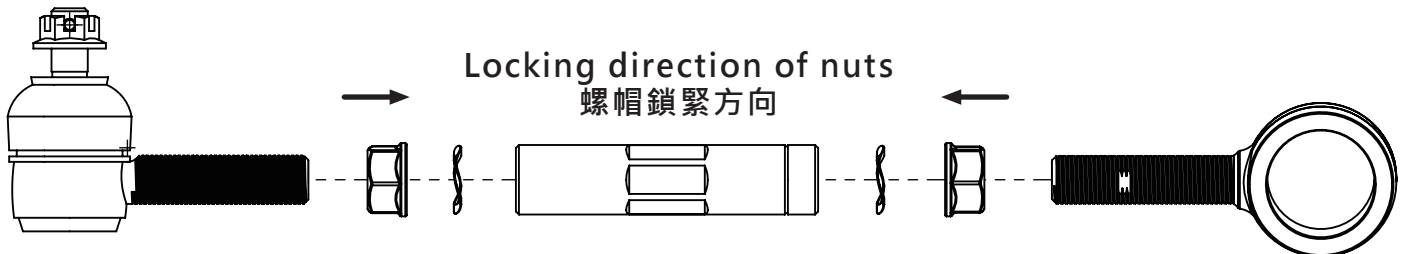

※ Safety adjustment length: Within 40mm (20mm at each end).
調整安全長度40mm以內

